



EDSHOW

Gelato and pastry display cabinet



A spectacular view from every angle

3DShow is the ideal format to maximize the display appeal of artisanal ice cream. It enhances the three-dimensional display of the product and provides an impressive view from every angle thanks to the front and sides of the display case, together with the ice cream tubs, all being completely transparent.





Excellent gelato
visibility.

Eccellente visibilità
del gelato.

IT

Una vista spettacolare da ogni punto di vista.

3DShow è il palcoscenico ideale per esaltare al massimo il food appeal del gelato artigianale, valorizzare al meglio la tridimensionalità del prodotto e regalare una vista mozzafiato da ogni punto di vista grazie ai fianchi, al frontale della vasca refrigerata e alle vaschette gelato completamente trasparenti.

FR

Une vue extraordinaire de chaque point de vue.

3DShow c'est la scène idéale pour exalter au maximum le food appeal de la glace artisanale, mettre en valeur au mieux la tridimensionnalité du produit et offrir une vue excellente de chaque point de vue grâce aux côtés, au vitre frontale du bac réfrigérant et aux bacs complètement transparents.

DE

Eine spektakuläre Aussicht von jedem Standpunkt.

3DShow ist die ideale Bühne Um die Anziehungskraft des Eises eigener Herstellung hervorzuheben, den dreidimensionalen Charakter am Besten zur Geltung zu bringen. Und einen atemberaubenden Blick von jedem Standpunkt geben, dank zu den Seiten, dem Frontglass und die komplett durchsichtigen Packungen.

ES

Una visión espectacular desde todos los puntos de vista.

3DShow es el escenario ideal para ensalzar el "food appeal" del helado artesanal, apreciar mejor la tridimensionalidad del producto y ofrecer una visión arrebatadora desde todos los ángulos gracias a los laterales, al frontal del expositor y a los recipientes de helado completamente transparentes.



3DSHOW

Gelato, star of its own show.

3DShow is the result of a harmonious combination of surfaces, materials and transparencies that revolutionize the standards of artisanal ice cream display. The narrow steel side supports give a panoramic view of the product. The holders for the transparent ice cream tubs and the top to bottom LED lighting system make the ice cream appear to float inside the display case.



IT

Il gelato protagonista nello spettacolo del gusto

3DShow nasce da una combinazione armonica di superfici, materiali e trasparenze che rivoluziona i paradigmi dell'esposizione del gelato artigianale. I montanti laterali in acciaio a ridotto spessore agevolano una visione panoramica del prodotto. I supporti per le vaschette trasparenti ed il sistema di illuminazione combinata full-led dall'alto e dal basso fanno apparire il gelato sospeso all'interno della vetrina.

DE

Das Eis ist der Protagonist In der Vorstellung des Geschmacks.

3DShow ergibt sich aus einer harmonische Kombination von Oberflächen, Materialien und Transparenz, welche das Paradigma der Exposition des Handwerkseises revolutioniert. Die seitlichen Stahlstützen, die eine reduzierte Dicke haben, ermöglichen einen Überblick über dem Produkt. Die Halterungen für die transparenten Schalen und die kombinierte full-LED Beleuchtungsanlage von oben und unten darstellen das wie in der Luft schwebenden Eis im inneren des Gehäuses.

FR

La glace protagoniste du spectacle du goût.

3DShow nait d'une combinaison harmonieuse de surfaces, de matériaux et de transparences qui révolutionne les modèles de présentation de la glace artisanale. Les montants latéraux en acier à l'épaisseur réduit facilitent la vue panoramique du produit. Les supports pour le bacs transparents et le système d'éclairage combiné full-led d'en haut et d'en bas font sembler la glace suspendue à l'intérieur de la vitrine.

ES

El helado como protagonista en el espectáculo del sabor.

3DShow nace de una combinación armónica de superficies, materiales y transparencias que revolucionan los prototipos de exposición del helado artesanal. Los laterales de acero de espesor reducido facilitan una visión panorámica del producto. Los soportes de los recipientes transparentes y el sistema de iluminación con tecnología full LED en la parte superior e inferior del expositor muestran el helado suspendido en el interior de la vitrina. ahorro energético.





Top performance without sacrificing energy saving

3DShow is equipped with a high-performance on-board or remote condensing unit which, together with a system of double ventilation, ensures a constant and uniform temperature in every part of the display case, resulting in the optimization of energy consumption and the consequent savings in operating cost.



IT

Prestazioni al top senza rinunciare al risparmio energetico

3DShow è equipaggiata con unità condensatrici a bordo o remote ad alte prestazioni che, in tandem con il sistema a doppia ventilazione, coniugano performance incredibili dal punto di vista della refrigerazione, costante ed uniforme in ogni punto della vasca espositiva, con l'ottimizzazione dei consumi e il conseguente risparmio energetico e dei costi di esercizio.

DE

Spitzenleistung, ohne auf die Energiesparung zu verzichten.

3DShow ist mit externen oder eingebauten Hochleistungs-Kondensationsanlagen ausgestattet. Die, zusammen mit dem Doppel Lüftungssystem, unglaublichen Leistungen aus der Sicht der Kältetechnik kombinieren, welche konstant und gleichmäßig in jedem Punkt der Ausstellungswanne, mit der Optimierung des Konsums und die anschließende Energieeinsparung.

FR

Prestations au top sans renoncer à l'épargne énergétique

3DShow est équipé avec des unités de condensation intégrées ou télécommandées assurant des hautes prestations qui, avec un système de double ventilation, assurent au même temps des performances incroyables du point de vue de la réfrigération, qui se maintient constante et uniforme à chaque point de la vitrine, l'optimisation des consommations et le conséquent épargne énergétique et des coûts d'exercice.

ES

Máximas prestaciones sin renunciar al ahorro energético

3DShow está equipado con unidades de condensación incorporadas o remotas con elevadas prestaciones que, junto al sistema de doble ventilación, crean un rendimiento increíble desde el punto de vista de la refrigeración constante y uniforme en todos los puntos del expositor, con la optimización del consumo y, como consecuencia, del ahorro energético.





2030 Phase-out F-GAS

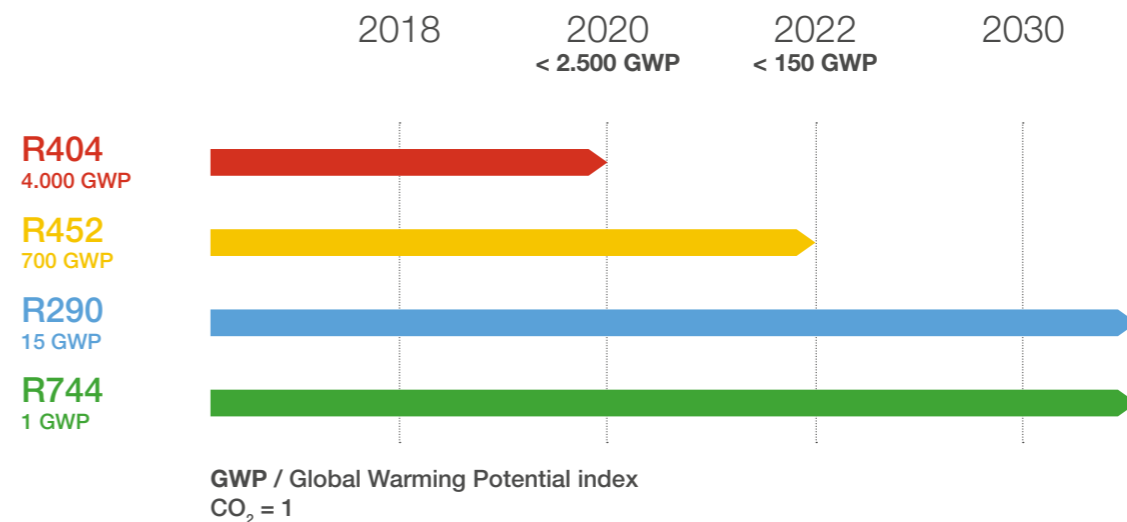

EUROPEAN REGULATION F-GAS 517/2014

The future is in the air

For ISA, sustainability is not only confined to the product but encompasses a great deal more: it is also a production process and is, above all, respect for the person and the environment.

You too can help make a difference, by choosing ARIA and becoming an ambassador for a new model of development. With the simplicity and the constancy of daily actions. From today, thanks to ISA research and development, there is now eco-friendly products that use natural refrigerant not only as an expanding agent in insulating foams but also as a refrigerant in the fridge system.



IT

Per ISA la sostenibilità non si limita al solo prodotto, ma è molto di più: è anche processo produttivo e soprattutto è rispetto della persona e dell'ambiente. Anche tu puoi contribuire a fare la differenza, scegliendo "ARIA" e diventando ambasciatore di un nuovo modello di sviluppo. Con la semplicità e la costanza dei gesti quotidiani. Da oggi grazie alla ricerca e sviluppo ISA è possibile avere una gamma di prodotti ecosostenibili che utilizzano i refrigeranti naturali non solo come agente espandente nelle schiume isolanti ma anche come refrigerante nell'impianto frigo.

FR

Pour Isa, la durabilité ne se limite pas uniquement au produit, c'est beaucoup plus: c'est aussi un procédé de production et c'est surtout le respect de la personne et de l'environnement. Vous êtes en mesure de contribuer à faire la différence, en choisissant ARIA et en devenant l'ambassadeur d'un nouveau modèle de développement. Avec la simplicité et la constance des gestes quotidiens. Grâce à la recherche et au développement d'ISA, il est aujourd'hui possible d'avoir une gamme de produits encore plus respectueux de l'environnement, qui utilisent le réfrigérant naturel CO₂ non seulement comme agent d'expansion des mousses isolantes mais aussi comme réfrigérant du réfrigérateur.

DE

Für Isa beschränkt sich die Nachhaltigkeit nicht nur auf das Produkt, sie umfasst weit mehr: Sie ist auch der Herstellungsprozess und vor allem schützt sie die Personen und die Umwelt. Auch Sie können den Unterschied machen, indem Sie sich für ARIA entscheiden und Botschafter eines neuen Entwicklungsmodells werden. Mit der Schlichtheit und Beständigkeit der alltäglichen Gesten. Seit heute ist es dank der Isa Forschung und Entwicklung möglich, unter einer noch umweltfreundlicheren Bandbreite von Produkten auszuwählen, die das natürliche Kältemittel CO₂ nicht nur als Schäummittel im Isolierschaum sondern auch als Kühlmittel in Kühlgeräten verwenden.

ES

Para Isa, la sostenibilidad no se limita únicamente al producto, sino que es algo más: también es proceso de producción y, sobre todo, respeto por la persona y el medio ambiente. También Tú puedes contribuir a marcar la diferencia, eligiendo ARIA y convirtiéndote en embajador de un nuevo modelo de desarrollo, con la simplicidad y constancia de los gestos cotidianos. Desde hoy, gracias a la investigación y al desarrollo de Isa, es posible tener una gama de productos mucho más sostenibles ecológicamente que utilizan el refrigerante natural CO₂ no sólo como agente expansor en las espumas aislantes sino también como refrigerante en la instalación frigorífica.



3DSHOW



Gelato

3DSHOW

H 117 • 135

P 110

L 120 • 155 • 170 • 190 • 220

Gelato

Installation

- Plug-in
- Remote (optional)

Configuration

- Canalized (optional)
- Dual Temperature (optional)

Temperature

-20/+2 °C

Refrigerant

R404A
R744 (on request)

Refrigeration

Ventilated double-flow

Compressor

Semi-Hermetic

Defrost

Reverse cycle

Climate class

4

Upper glass

Heated stratified
with switch

Front glass

Heated stratified

Side glasses

Heated stratified

Opening system

Servo, bottom-up
opening system

Rear closing system

Plexiglass sliding doors

Work top

- Solid surface White
- Fenix Black

Internal display surface

- Trays painted RAL 9004
- Trays inox

Lightning

Led 5700 K°

Equipment handling

Swivel casters with brake
and height adjustable feet

Installazione

- Plug-in
- Remoto (optional)

Configurazione

- Canalizzabile (optional)
- Dual Temperature (optional)

Temperatura

-20/+2 °C

Refrigerante

R404A
R744 (su richiesta)

Refrigerazione

Ventilata doppia mandata

Compressore

Semi-Ermetico

Sbrinamento

Inversione di ciclo

Classe Climatica

4

Vetro superiore

Stratificato riscaldato
(disattivabile)

Vetro frontale

Stratificato riscaldato

Vetri laterali

Stratificati riscaldati

Apertura anteriore

Apertura servoassistita
verso l'alto

Chiusura posteriore

Scorrevoli in Plexiglass

Piano di servizio

- Superficie solida bianca
- Fenix Nero

Piano interno vasca

- Vassoi verniciati RAL 9004
- Vassoi inox

Illuminazione

Led 5700 K°

Movimentazione

Ruote pivotanti con freno
e piedini regolabili in altezza



Dual Temperature





Designed with maximum flexibility to allow seasonal product display management. The Dual Temperature function (optional) allows the display cabinet to change simply, the operating temperature for Ice Cream and Pastry Products. This allows one cabinet to offer seasonal flexibility without increasing floor space.

Massima flessibilità e perfetta gestione dei cicli stagionali. La funzione Dual Temperature (optional) permette alla vetrina di passare con estrema semplicità da Gelateria a Pasticceria, e viceversa, permettendovi di avere un locale multifunzionale con un unico prodotto: possibilità di variare stagionalmente l'offerta e il layout del vostro spazio.

		120	155	170
External dimensions (LxDxH)	H117	1172 x 1104 x 1170 mm	1502 x 1104 x 1170 mm	1667 x 1104 x 1170 mm
Dimensioni esterne (LxPxH)	H135	1172 x 1104 x 1350 mm	1502 x 1104 x 1350 mm	1667 x 1104 x 1350 mm
Capacity (gross/net)	H117	685 / 147 lt	901 / 193 lt	1009 / 216 lt
Capacità (lorda/netta)	H135	824 / 147 lt	1083 / 193 lt	1212 / 216 lt
Net weight	H117	330 kg	390 kg	425 kg
Peso netto	H135	340 kg	400 kg	435 kg
Refrigeration		Ventilated Ventilata		
Refrigerazione				
Refrigerant		R404A		
Refrigerante				
Climate class		4		
Classe climatica				
Operating conditions		30 °C / 55 %RH		
Condizioni ambientali				
Cabinet capacity range		-20/+2 °C		
Temperatura di regolazione				
Product temperature		-16/-14 °C		
Temperatura prodotto				
Compressor (type)		1 Semi-Hermetic 1 Semi-Ermetico		
Compressore (tipologia)				
Defrost		Reverse Cycle Inversione di Ciclo		
Sbrinamento				
Power supply		400 V / 3 Ph / 50 Hz		
Alimentazione				
Electrical input (nominal)		1740 W / 3,1 A	2470 W / 6,3 A	2780 W / 6,8 A
Assorbimento elettrico (regime)				
Electrical input (defrost)		3260 W / 7,9 A	3870 W / 8,5 A	4250 W / 9,6 A
Assorbimento elettrico (sbrinamento)				





Technical sheet about models whit condensing unit included with air cooled
Dati tecnici riferiti a modelli con unità a bordo con condensazione ad aria

Setup Allestimento

5 Lt 360 x 165 x 120 h		12	16	18
5 Lt 360 x 250 x 80 h		8	10	12
Ice cream stick container Vaschetta stecchi		8	10	12
Single portions container Vaschetta monoporzioni		8	10	12
Pastry trays Vassoi pasticceria		•	•	•





Available colours - Colori disponibili

Front panel (1) Pannello frontale

-  RAL 9003
-  Corian™ Glacier White
-  Fenix™ Nero
-  RAL on demand





• Standard / Di serie

Front grid (2) Griglia frontale

-  RAL 9003
-  Corian™ Glacier White
-  Fenix™ Nero
-  RAL on demand

• Standard / Di serie

Side panels (3) Fianchi laterali

-  RAL 9003
-  Corian™ Glacier White
-  Fenix™ Nero
-  RAL on demand

• Standard / Di serie

	190	220
1832 x 1104 x 1170 mm	1832 x 1104 x 1170 mm	2162 x 1104 x 1170 mm
1832 x 1104 x 1350 mm	1832 x 1104 x 1350 mm	2162 x 1104 x 1350 mm
1116 / 239 lt	1332 / 285 lt	
1341 / 239 lt	1600 / 285 lt	
460 kg	525 kg	
470 kg	535 kg	
	Ventilated Ventilata	
	R404A	
	4	
	30 °C / 55 %RH	
	-20/+2 °C	
	-16/-14 °C	
	1 Semi-Hermetic 1 Semi-Ermetico	
	Reverse Cycle Inversione di Ciclo	
	400 V / 3 Ph / 50 Hz	
4000 W / 11,5 A	4770 W / 13,5 A	
5000 W / 12,5 A	5600 W / 3,9 A	

20	24
12	16
12	16
12	16
•	•

H117

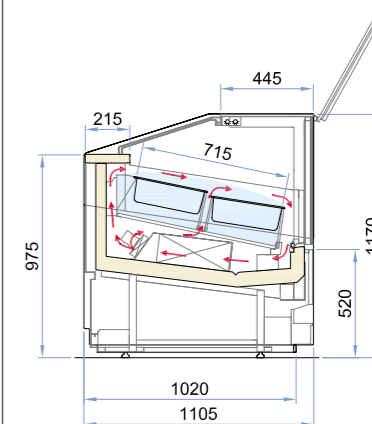

H135

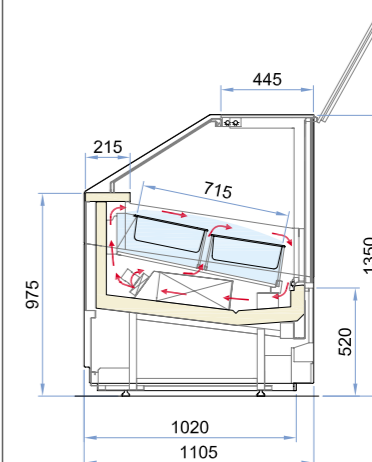



3DSHOW



Pastry

3DSHOW

H 117 • 135

P 110

L 120 • 170 • 220

Pastry

Installation

- Plug-in
- Remote (optional)

Configuration

Canalized (optional)

Temperature

+1/+10 °C

Refrigerant

R404A

Refrigeration

Ventilated

Compressor

Hermetic

Defrost

Off cycle

Climate class

3

Upper glass

Heated stratified with switch

Front glass

Heated stratified glass

Side glasses

Heated stratified glass

Opening system

Servo, bottom-up opening system

Rear closing system

Plexiglass sliding doors

Work top

- Solid surface White
- Fenix Black

Internal display surface

- Trays painted RAL 9004
- Trays inox

Lightning

Led 5700 K°

Equipment handling

Swivel casters with brake and height adjustable feet

Installazione

- Plug-in
- Remoto (optional)

Configurazione

Canalizzabile (optional)

Temperatura

+1/+10 °C

Refrigerante

R404A

Refrigerazione

Ventilata

Compressore

Ermetico

Sbrinamento

Fermata compressore

Classe Climatica

3

Vetro superiore

Stratificato riscaldato (disattivabile)

Vetro frontale

Stratificato riscaldato

Vetri laterali

Stratificati riscaldati

Apertura anteriore

Apertura servoassistita verso l'alto

Chiusura posteriore

Scorrevoli in Plexiglass

Piano di servizio

- Superficie solida bianca
- Fenix Nero

Piano interno vasca

- Vassoi verniciati RAL 9004
- Vassoi inox

Illuminazione

Led 5700 K°

Movimentazione

Ruote pivotanti con freno e piedini regolabili in altezza



	120	170	220
External dimensions (LxDxH) H117	1172 x 1104 x 1170 mm	1667 x 1104 x 1170 mm	2162 x 1104 x 1170 mm
Dimensioni esterne (LxPxH) H135	1172 x 1104 x 1350 mm	1667 x 1104 x 1350 mm	2162 x 1104 x 1350 mm
Capacity (gross/net) H117	685 / 267 lt	1009 / 393 lt	1332 / 518 lt
Capacità (lorda/netta) H135	824 / 267 lt	1212 / 393 lt	1600 / 518 lt
Net weight H117	330 kg	425 kg	525 kg
Peso netto H135	340 kg	435 kg	535 kg
Refrigeration Refrigerazione	Ventilated Ventilata		
Refrigerant Refrigerante	R404A		
Climate class Classe climatica	3		
Operating conditions Condizioni ambientali	25 °C / 60 %RH		
Product temperature Temperatura prodotto	+1/+10 °C		
Compressor (type) Compressore (tipologia)	1 Hermetic 1 Ermetico		
Defrost Sbrinamento	Off Cycle Fermata compressore		
Power supply Alimentazione	230 V / 1 Ph / 50 Hz		
Electrical input (nominal) Assorbimento elettrico (regime)	690 W / 6 A	840 W / 7 A	1230 W / 9 A
Electrical input (defrost) Assorbimento elettrico (sbrinamento)	200 W / 3 A	230 W / 3 A	370 W / 4 A
<small>Technical sheet about models whit condensing unit included with air cooled Dati tecnici riferiti a modelli con unità a bordo con condensazione ad aria</small>			
Setup Allestimento			
Pastry trays Vassoi pasticceria	•	•	•

H117

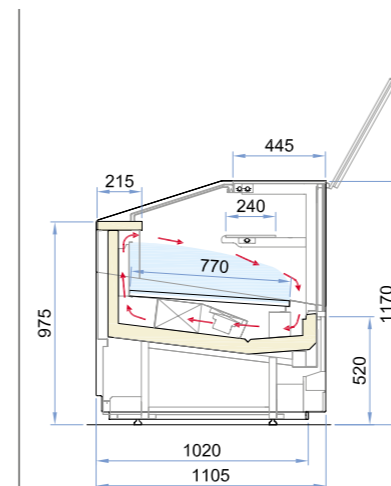

H135

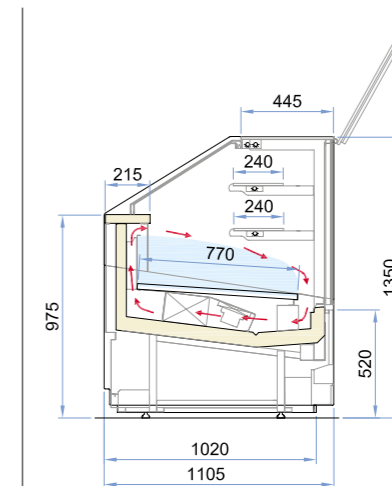

Available colours - Colori disponibili

Front panel (1)
Pannello frontale

- RAL 9003
- Corian™ Glacier White
- Fenix™ Nero
- RAL on demand

• Standard / Di serie

Front grid (2)
Griglia frontale

- RAL 9003
- Corian™ Glacier White
- Fenix™ Nero
- RAL on demand

• Standard / Di serie

Side panels (3)
Fianchi laterali

- RAL 9003
- Corian™ Glacier White
- Fenix™ Nero
- RAL on demand

• Standard / Di serie





ISA nasce in Umbria, nel cuore di quell'Italia rinomata in tutto il mondo per la sua eccellenza artigianale, industriale e creativa. Con quattro stabilimenti e la presenza in oltre 100 mercati globali ISA è uno dei player al mondo più importanti del mercato dell'arredamento per locali pubblici, delle vetrine e degli armadi refrigerati per gelateria e pasticceria e dell'arredamento professionale.

ISA was established in Umbria, in the heart of Italy, a nation that is famed all over the world for its artisan, industrial and creative excellence. With four sites and the presence in over 100 global markets, ISA is one of the most important players on furniture market for public places, ice cream display cabinets, pastry display cases and professional furniture.

ISA nait en Ombrie, au milieu de cette partie-là d'Italie célèbre dans tout le monde pour son excellence artisanale, industrielle et créative. Avec quatre usines et en étant sur plus de 100 marchés globaux, ISA est un des joueurs les plus importants sur le marché international de l'ameublement pour locaux publiques, de vitrines et d'armoires d'exposition réfrigérées pour glacerie et pâtisserie et de l'ameublement professionnel.

ISA wurde in Umbrien gegründet, im Herzen Italiens, die in der ganzen Welt für ihre handgefertigte, industrielle und kreative Vorzüglichkeit berühmt ist. Mit vier Werkanlagen und dank der Anwesenheit in mehr als 100 ISA Global Märkten, ist ISA einer der wichtigsten Player der weltweiten Möbelmarkt für Lokale, Vitrinen und Kühlschränke für Eisdiele und Konditorei und professionelle Einrichtung.

ISA nace en Umbria, en el corazón de una Italia de renombre en todo el mundo por su artesanía, industria y creatividad excelentes. Con cuatro establecimientos y presente en más de 100 mercados globales, ISA es uno de los principales protagonistas mundiales del mercado del mobiliario profesional y de locales públicos así como de los expositores y refrigeradores para heladería y pastelería.



La ISA S.p.A. nell'ambito del continuo miglioramento del prodotto, si riserva il diritto di modificare in qualsiasi momento, senza preavviso, le caratteristiche tecniche ed estetiche dei propri modelli.

In the interest of continual product improvements, ISA S.p.A. reserves the right to make changes in technical specifications and accessories at any moment and without prior notice.



ISA S.p.A.

via Madonna di Campagna 123
06083 Bastia Umbra (PG)
Italy

T. +39 075 801 71

F. +39 075 800 09 00

E. customerservice@isaitaly.com

www.isaitaly.com



428100171300 M1218H0

