

# Mito Winner LX



Gelato cabinets at fan ventilated refrigeration, oversized horizontal finned evaporator and reverse cycle defrost system. One piece body with ecological polyurethane insulation (HCFC & HFC free), foamed with CO<sub>2</sub> - 60 mm thick. Display base and service top in bright stainless steel, rear panel in carbon steel, powder painted, external base in painted sheet. Upper structure with silver-colored anodized aluminium supports. Tempered glasses. Front pyrolytic lift-up curved anti-fog glass with hydraulic pistons. Profile, complete light heading in silver-colored anodized aluminium; double neon lighting. Operator side closure with pull-out methacrylate sliding doors. Main structure and basement in carbon steel painted with epoxy powder, adjustable feet. Control board on the operator side, electronic board and digital thermometer inside the tank, temperature control set at -20/+ 2 °C. Side panels with insulation and anti-scratch lacquering.

Vetrine gelato a refrigerazione ventilata con evaporatore orizzontale maggiorato. Sbrinatorio automatico ad inversione di ciclo. Scocca monolitica coibentata in poliuretano ecologico (HCFC & HFC free) espanso a CO<sub>2</sub> con spessore mm 60. Piano espositivo, piano di servizio in acciaio inox finitura lucida, pannello lato operatore in acciaio al carbonio verniciato a polvere, fondo esterno vasca in lamiera preverniciata. Sovrastruttura con montanti in alluminio anodizzato colore argento opposti al lato operatore. Vetri in cristallo temperato. Vetro frontale curvo pirolitico anti-condensa, con apertura verso l'alto servoassistita. Profilo, plafoniera e top in alluminio anodizzato colore argento, illuminazione con doppio Neon. Chiusura lato operatore con scorrevoli in policarbonato, rimovibili. Struttura portante e basamento in acciaio al carbonio verniciato a polvere epossidica, con piedini regolabili. Quadro comandi posizionato su lato operatore con centralina elettronica e termometro digitale in vasca, set di regolazione temperatura predisposto per -20/+ 2 °C. Fianchi coibentati laccati con trattamento antigraffio.



**ENERGY SAVING**  
EC Fan motor



**INSTALLATION**  
Plug-in / Remote unit



**TEMPERATURE**  
-20/+2°C



**DOORS SYSTEM**  
Lids



**DEFROST**  
Reverse cycle



**CLIMATIC CLASS**  
7



## Mito Winner LX **Catalog** - Catalogo

Model Modello	Code Codice	Condensing unit included Unità condensatrice a bordo			Condensing unit not included Senza unità condensatrice a bordo	Remote condensing unit included (up to 20 mt) Unità condensatrice remota compresa (fino a 20 mt)		Wheel Kit Kit ruote	LED Lightning Luci a LED	NEON Lightning Luci a NEON
		R404A Air Aria	Water Acqua	Air+Water Aria+Acqua		Air Aria	Air+Water Aria+Acqua			
RV	12	WIM0001200L	*****	*****	*****	*****	*****	*****	*****	*****
	16	WIM0001600L	*****	*****	*****	*****	*****	*****	*****	*****
	18	WIM0001800L	*****	*****	*****	*****	*****	*****	*****	*****
	20	WIM0002000L	*****	*****	*****	*****	*****	*****	*****	*****
	24	WIM0002400L	*****	*****	*****	*****	*****	*****	*****	*****
	AE 22,5	WIM0AE2200L	*****	*****	*****	*****	*****	-	*****	*****
	AI 22,5	WIM0AI2200L	*****	*****	*****	*****	*****	-	*****	*****
	AE 45	WIM0AE4500L	*****	-	*****	*****	*****	-	*****	*****
	AI 45	WIM0AI4500L	*****	-	*****	*****	*****	-	*****	*****

## Mito Winner LX **Technical features** - Caratteristiche tecniche

	12	16	18
<b>External dimensions [LxDxH]</b> Dimensioni esterne [LxPxH]	1110 x 1165 x 1376 mm	1440 x 1165 x 1376 mm	1605 x 1165 x 1376 mm
<b>Capacity [gross/net]</b> Capacità [lorda/netta]	703 / 120 lt	932 / 160 lt	1047 / 180 lt
<b>Net weight</b> Peso netto	235 kg	310 kg	335 kg
<b>Refrigeration</b> Refrigerazione	Ventilated - Ventilata		
<b>Refrigerant</b> Refrigerante	R404A		
<b>Climatic class</b> Classe climatica	7		
<b>Operating conditions</b> Condizioni ambientali	35 °C / 75 %RH		
<b>Cabinet capacity range</b> Temperatura di regolazione	-20/+2 °C		
<b>Product temperature</b> Temperatura prodotto	-16/-14 °C		
<b>Compressor (type)</b> Compressore [tipologia]	1 Hermetic - 1 Ermetico	2 Hermetic-2 Ermetico	
<b>Defrost</b> Sbrinamento	Reverse cycle - Inversione ciclo		
<b>Power supply</b> Alimentazione	230 V / 1 Ph / 50 Hz		
<b>Electrical input [standard]</b> Assorbimento elettrico	1350 W / 6,7 A	1750 W / 7,8 A	1800 W / 8 A
<b>Electrical input [defrost]</b> Assorbimento elettrico	2800 W / 11 A	2980 W / 11,7 A	3100 W / 12,2 A

**Stainless steel containers**

Vaschette inox

**5 Lt**

 360 x 165 x 120h  
9001990000005

\*\*\*\*\* each/cad.

**5 Lt**

 360 x 250 x 80h  
9001990000017

\*\*\*\*\* each/cad.

**7 Lt**

 360 x 165 x 150h  
9001990000007

\*\*\*\*\* each/cad.

**10 Lt**

 360 x 250 x 120h  
9001990000010

\*\*\*\*\* each/cad.

**12 Lt**

 360 x 250 x 150h  
9001990000012

\*\*\*\*\* each/cad.



**5 Lt**

 360 x 185 x 120h (trapezoidali)  
9290100024200

\*\*\*\*\* each/cad.

12	8	12	8	8	-
16	10 <b>+KitSup ***</b> 9004400000029	16	10 <b>+KitSup ***</b> 9004400000029	10 <b>+KitSup ***</b> 9004400000029	-
18	12	18	12	12	-
20	12 <b>+KitSup ***</b> 9004400000028	20	12 <b>+KitSup ***</b> 9004400000028	12 <b>+KitSup ***</b> 9004400000028	-
24	16	24	16	16	-
14	9 <b>+KitSup ***</b> 9004400000027	14	9 <b>+KitSup ***</b> 9004400000027	9	-
14	9 <b>+KitSup ***</b> 9004400000027	14	9 <b>+KitSup ***</b> 9004400000027	9	-
12	7 <b>+KitSup ***</b> 9673000000097	12	7 <b>+KitSup ***</b> 9673000000097	7	14 <b>+KitSup ***</b> 9004400001212
12	7 <b>+KitSup ***</b> 9673000000098	12	7 <b>+KitSup ***</b> 9673000000098	7	14 <b>+KitSup ***</b> 9004400001212

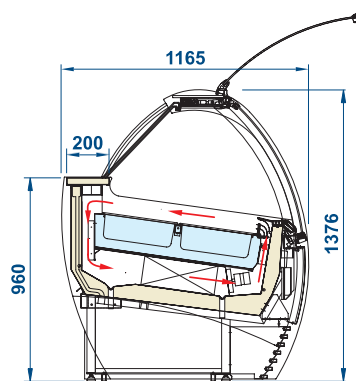
20	24
1770 x 1165 x 1376 mm	2100 x 1165 x 1376 mm
1162 / 200 lt	1392 / 240 lt
355 kg	445 kg
Ventilated - Ventilata	
R404A	
7	
35 °C / 55 %RH	
-20/+2 °C	
-16/-14 °C	
2 Hermetic - 2 Ermetico	
Reverse cycle - Inversione ciclo	
230 V / 1 Ph / 50 Hz	
2600 W / 10,2 A	2650 W / 10,4 A
3500 W / 13,7 A	3600 W / 14,1 A

**Section - Sezioni**

# Mito Winner LX **Technical features** - Caratteristiche tecniche

## Section - Sezioni

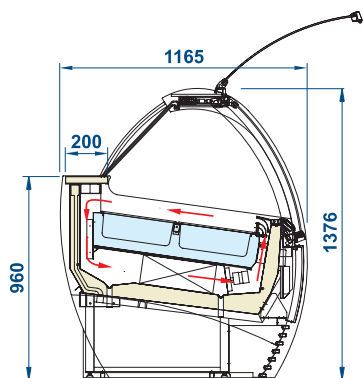

	<b>AE 22,5</b>	<b>AI 22,5</b>	<b>AE 45</b>	<b>AI 45</b>
<b>External dimensions [LxDxH]</b> Dimensioni esterne [LxPxH]	1595 x 1165 x 1376 mm	1633 x 1165 x 1376 mm	1716 x 1165 x 1376 mm	1726 x 1165 x 1376 mm
<b>Capacity [gross/net]</b> Capacità [lorda/netta]	595 / 152 lt		510 / 130 lt	
<b>Net weight</b> Peso netto	345 kg			
<b>Refrigeration</b> Refrigerazione	Ventilated - Ventilata			
<b>Refrigerant</b> Refrigerante	R404A			
<b>Climatic class</b> Classe climatica	7			
<b>Operating conditions</b> Condizioni ambientali	35 °C / 75 %RH			
<b>Cabinet capacity range</b> Temperatura di regolazione	-20/+2 °C			
<b>Product temperature</b> Temperatura prodotto	-16/-14 °C			
<b>Compressor [type]</b> Compressore [tipologia]	1 Hermetic - 1 Ermetico			
<b>Defrost</b> Sbrinamento	Reverse cycle - Inversione ciclo			
<b>Power supply</b> Alimentazione	230 V / 1 Ph / 50 Hz			
<b>Electrical input [standard]</b> Assorbimento elettrico	1500 W / 5,9 A		1800 W / 8 A	
<b>Electrical input [defrost]</b> Assorbimento elettrico	1800 W / 7,1 A		3100 W / 12,2 A	

# Mito Winner LX Available Colours - Colori disponibili



GELATO PRO

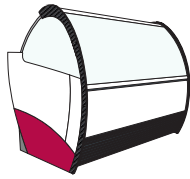

1

<b>Side Panel</b> Fianco laterale			<b>Front panel</b> Pannello frontale			<b>Side Panel</b> Fianco laterale			<b>Front panel</b> Pannello frontale			
Carbon look	Rosso carminio RAL 3002	Bianco segnale RAL 9003	Bianco segnale RAL 9003	Nero traffico RAL 9017	Bianco segnale RAL 9003	Bianco segnale RAL 9003	Bianco segnale RAL 9003	Bianco segnale RAL 9003	Bianco segnale RAL 9003	Viola bordeaux RAL 4004	Bianco perla RAL 1013	Bianco perla RAL 1013

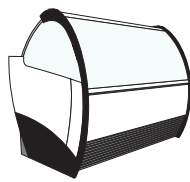

2

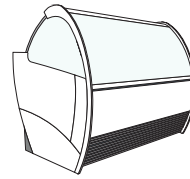

3

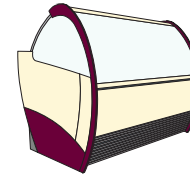

4

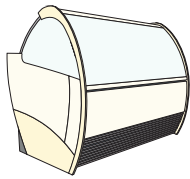

5

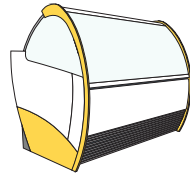

6

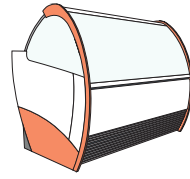

7

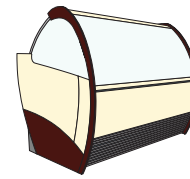

8

<b>Side Panel</b> Fianco laterale		<b>Front panel</b> Pannello frontale		<b>Side Panel</b> Fianco laterale		<b>Front panel</b> Pannello frontale		<b>Side Panel</b> Fianco laterale		<b>Front panel</b> Pannello frontale	
Bianco perla RAL 1013	Bianco puro RAL 9010	Bianco puro RAL 9010	Giallo zinco RAL 1018	Bianco segnale RAL 9003	Bianco segnale RAL 9003	Arancio pastello RAL 2003	Bianco segnale RAL 9003	Bianco segnale RAL 9003	Marrone mogano RAL 8016	Bianco perla RAL 1013	Bianco perla RAL 1013

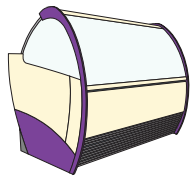

9

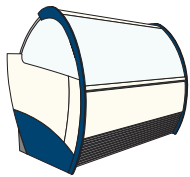

10

<b>Side Panel</b> Fianco laterale		<b>Front panel</b> Pannello frontale		<b>Side Panel</b> Fianco laterale		<b>Front panel</b> Pannello frontale	
Porpora traffico RAL 4006	Bianco perla RAL 1013	Bianco perla RAL 1013	Blu segnale RAL 5005	Bianco puro RAL 9010	Bianco puro RAL 9010	Bianco puro RAL 9010	Bianco puro RAL 9010

## Mito Winner LX **Optionals** - Elementi opzionali

Item	Accessorio	Mod.	Code	Price
White cone holder	Portaconi completo bianco	-	9001390900700	*****
Scoop washer, water tap, consolle R	Lavaporzionatore con rubinetto e consolle portaoggetti DX	-	9001920000001	*****
Scoop washer, water tap, consolle L	Lavaporzionatore con rubinetto e consolle portaoggetti SX	-	9001920000000	*****
Kit labels flavours	Kit targhette gusti	12	9004400000012	*****
		16	9004400000016	*****
		18	9004400000018	*****
		20	9004400000020	*****
		24	9004400000024	*****
		AI/AE	9004400000016	*****
Stainless steel tray V1 2x2 5 lt	Vassoio inox V1 2x2 5 lt	-	9001990100010	*****
Stainless steel tray V2 2x3 5 lt	Vassoio inox V2 2x3 5 lt	-	9001990100015	*****
Stainless steel tray V3	Vassoio inox V3 kit 4 vassoi	AE 45	9001990100016	*****
Stainless steel tray V4	Vassoio inox V4 kit 4 vassoi	AI 45	9001990100017	*****
Stainless steel tray V11	Vassoio inox V4 kit 4 vassoi	AE 22,5 AI 22,5	9001990100026	*****

## Mito Winner LX **Customizable area** - Aree personalizzabili



Mod. 12	1012 x 370 mm
Mod. 16	1342 x 370 mm
Mod. 18	1507 x 370 mm
Mod.20	1675 x 370 mm
Mod. 24	2002 x 370 mm